

RONGTA

User Manual

RPP320N Mobile Label Printer

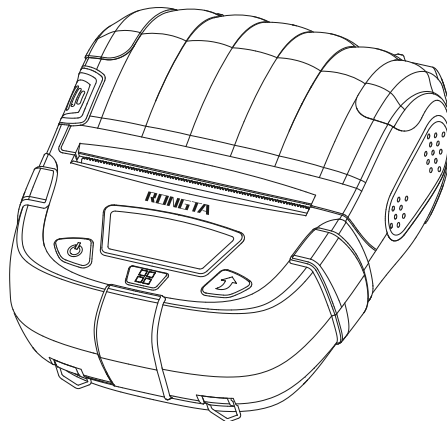

Please read this Manual carefully before using the printer and keep it for future reference

Contents

| | | | |
|------------------------------------|----|--|----|
| Preface..... | 1 | 4.3 Self-test..... | 12 |
| About This Manual..... | 1 | V. Icon description..... | 13 |
| Icons and Practices..... | 1 | VI. Communication..... | 14 |
| Related Manual Information..... | 1 | 6.1 USB Communication..... | 14 |
| Safety Instruction..... | 2 | 6.2 WiFi Communication..... | 15 |
| I. Standard Configuration..... | 5 | 6.3 Bluetooth Communication | 16 |
| II. Appearance and Components..... | 6 | VII. Repair and Maintenance..... | 17 |
| III. Preparation Before Use..... | 7 | 7.1 Daily Maintenance of Printer..... | 17 |
| 3.1 Battery Installation..... | 7 | 7.2 Use and Storage of Printing Paper..... | 17 |
| 3.2 Printing Paper Loading..... | 8 | VIII. Troubleshooting..... | 18 |
| 3.3 Battery Charging..... | 9 | IX. Appendix..... | 19 |
| IV. Basic use Functions..... | 10 | 9.1 Printer Parameters..... | 19 |
| 4.1 Basic Functions..... | 10 | 9.2 Battery Recycling..... | 20 |
| 4.2 Setting..... | 10 | | |

Preface



About This Manual

Thank you for purchasing the RPP320N mobile label printer produced by Rongta.

This Manual can help you easily learn to use this product. Please read this Manual carefully before using the printer and keep it properly so that everyone who uses this product can read it.

Icons and Practices

For your convenience, this Manual uses the following symbols (icons) and practices:

-  **WARNING** warns that improper use may result in property damage, serious injury or death.
-  **ATTENTION** indicates that improper use may result in personal injury or property damage.
-  **NOTE** indicates that the information listed allows you to use the product better or extend the service life of the product.

Related Manual Information

Various manuals provide detailed instructions for various technical problems.









The Programming Manual provides a detailed description of the product development.







The illustrations and text used in this Manual may differ from the actual product.





Safety Instruction





Please follow the following precautions when using the printer:

-  **ATTENTION** Do not disassemble the printer by yourself. Please read this Manual carefully before use.
-  **WARNING** Please turn off the power immediately in case of failure. When you notice smoke or odor coming from the printer or power adapter, please unplug the power adapter and remove the battery immediately. Please be careful not to get burnt.
-  **WARNING** Please do not use the printer near gas stations, fuel warehouses and other flammable materials.
-  **WARNING** During charging, the printer and power adapter must be placed in a ventilated place with the ambient temperature of 0°C - 45°C, and be sure to use the power adapter provided by the Company. The use of unapproved power adapters may be hazardous and also violates our warranty policy.
-  **ATTENTION** When the printer is printing, please do not open the cover of the paper bin; otherwise, unpredictable conditions may occur and the printer may even be damaged.
-  **ATTENTION** After printing, the print head is still at a high temperature. Do not touch it to avoid burns.
-  **ATTENTION** Please do not use dissolved matter (such as benzene thinner) to wipe the printer shell, and please keep the printer away from corrosive chemicals. You can only gently wipe the printer with a clean soft cloth.
-  **ATTENTION** Please use our original or approved printing paper; otherwise, it may lead to poor printing quality or even damage to the printer mechanism.







-  **ATTENTION** If the printer is to be stored for a long time, be sure to remove the battery from the printer and store it separately; otherwise, the battery may fail or even have leakage, which may damage the printer.
-  **ATTENTION** Make sure the printer is turned off before replacing the battery. If a power adapter is used, make sure the power is cut off before replacing the battery.
-  **ATTENTION** The printer can work stably at an ambient temperature of 0°C - 40°C. Too high or too low ambient temperature will lead to low printing quality.
-  **ATTENTION** The time that the printed text can be kept on the thermal printing paper is related to the paper quality. To print documents that need to be kept for a long time, please use long-lasting thermal printing paper.
-  **ATTENTION** This printer is suitable for areas under below 5000 meters (above sea level).

Please follow the following precautions when using the battery:

-  **ATTENTION** Please carefully read this Manual and symbols on the battery surface before use.
-  **WARNING** Please charge the battery in a cool and ventilated room. The high ambient temperature during charging will cause the battery to heat up, emit smoke, burn, deform, or even explode.
-  **WARNING** There are special protective circuits and devices inside the battery. Please do not disassemble the battery by yourself, or it will cause a short circuit or electrolyte leakage.
-  **WARNING** There is a risk of blindness if the electrolyte gets into the eye. In case of eye contact, rinse immediately with water and seek doctor's advice immediately.
-  **WARNING** Do not squeeze, mechanically vibrate or shake the battery, and short circuit of the battery is strictly forbidden.

-  **WARNING** Please do not put the battery into water; otherwise, it may result in internal short circuit, which may cause the battery to heat up, emit smoke, deform, damage or even explode.
-  **ATTENTION** Do not expose the battery to direct sunlight or put it in a place with excessive smoke and dust. Do not use the battery in a high humidity environment, such as a bathroom.
-  **ATTENTION** Please replace the battery if it cannot meet the performance requirements.
-  **ATTENTION** Keep the battery out of reach of children to prevent danger.
-  **ATTENTION** If you notice any discoloration or deformation of the battery, stop using it immediately.







Please carefully read this Manual and symbols on the surface of power adapter before use.

-  **WARNING** Do not disassemble or modify the power adapter. Do not use the power adapter if the power line is damaged; otherwise, it may cause electric shock, fire and damage to the power adapter.
-  **WARNING** Do not touch the power adapter with wet hands. If the power adapter comes into contact with water or other liquids, cut off the power supply immediately.
-  **WARNING** Please avoid short circuit, vibration or shaking of the power adapter.
-  **WARNING** Do not use the power adapter in a high humidity environment, such as a bathroom. The equipment is not waterproof and must not be exposed to rain or moisture.
-  **WARNING** Hold the power adapter body when unplugging. Simply pulling the power line will damage the wires.
-  **ATTENTION** Keep the power adapter out of reach of children to prevent danger.

I. Standard Configuration



The pictures are for reference only. If any item is damaged or missing, please contact the supplier.

| Standard accessories | | |
|---|---|--|
|  |  |  |
| RPP320N (1 set) | Battery (1 pcs) | Power charger (1 pcs) |
|  |  |  |
| USB cable (1 pcs) | Quick installation guide | Belt buckle (1 pcs) |

☺ The pictures are for reference only. If any item is damaged or missing, please contact the supplier.

II. Appearance and Components



□ Front View

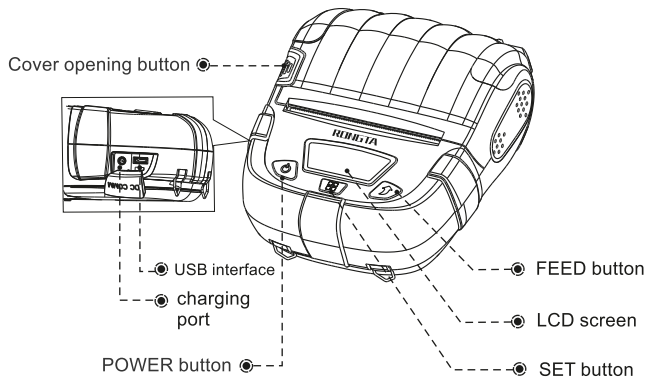

□ Rear View

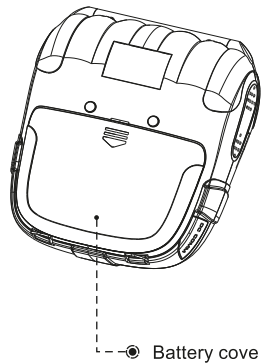

III. Preparation Before Use



3.1 Battery Installation

The battery is not installed in the printer before the product leaves factory.

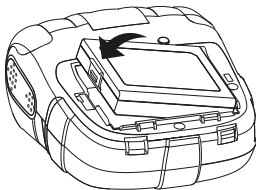



Load the battery into the main body according to the direction as shown in the figure.



Close the battery cover after the battery buckle is fastened.

 **Note:** The battery must be fully charged before using it for the first time. After storing for a long time, the battery also needs to be fully charged before reuse to achieve the best use effect.

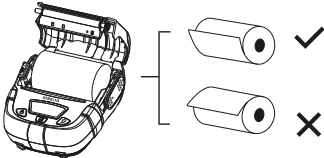
3.2 Printing Paper Loading

| | |
|---|---|
|  <p>Press the cover opening button to open the paper bin cover.</p> |  <p>Load paper roll into the paper bin according to the direction as shown in the figure.</p> |
|  <p>Pull out a part of paper roll and close the paper bin cover.</p> |  <p>Tear off the excessive paper according to the direction as shown in the figure</p> |

- ☺ **NOTE:** 1. Paper specification used by the printer: Paper width:80mm (One side can be adjusted) , paper roll diameter: 50mm.
2. Pay attention to the direction of paper roll. If it is placed in the wrong direction, it will lead to blank printing.
3. Be sure to pull a part of paper out of the paper bin.

3.3 Battery Charging

Plug the charger plug into the power socket, and the charger DC plug into the printer charging port.
(AC:100V~240V(50/60Hz))

⚠ WARNING If you use a power adapter not provided or approved by us,
the printer may be damaged.

⚠ ATTENTION Do not remove the battery while charging.

😊 NOTE You can print while charging.

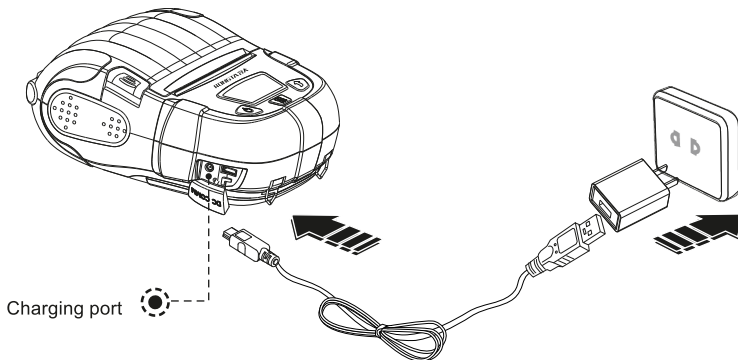

IV. Basic use Functions

4.1 Basic Functions

Power On: press and hold the POWER button for 3 seconds.

Power Off: When the printer is on, press and hold the POWER button.

FEED: Press the FEED button (under continuous feeding mode, press FEED button to feed paper of about 5mm; under label/black label mode, press FEED button to feed paper to seam label or black label.)

Auto sleep wake:

When the printer is turned on and has no button operation or data transmission within 10 seconds, it will automatically enter sleep mode. Press POWER button to wake up the printer (the printer will automatically wake up when data is received) .











4.2 Setting

Enter setting screen: During power-on state (non-sleep mode), press and hold SET button to enter the option screen.

Press SET button: Go to the next option.

Press FEED button: Change option parameters.

Press POWER button: Confirm settings and exit.

| | | |
|---|----------------------|---|
|  ●●●●●●●●◀▶ Do: Print Info | print self-test page | Press Power button to start printing self-test page |
|  ○●●●●●●●◀▶ Print Quality: 0-4 | 0-4 | Set wide range definition (coarse tuning) |
|  ○●●●●●●●◀▶ Darkness: 0-4 | 0-4 | Set small range definition (fine tuning) |
|  ○●●●●●●●◀▶ Speed: 0-4 | 0-4 | Set print speed |
|  ○○○●●●●●◀▶ language: English | EngLish | Set language |
|  ○○○○●●●●◀▶ Buzzer Set: Open | Open | Set whether to turn on the buzzer |
|  ○○○○○●○○○◀▶ Paper Type: Label | Label | Set according to the paper type used |
|  ○○○○○○●○○○◀▶ Cmd Model: TSC | TSPL/ESC/POS | Set command mode |
|  ○○○○○○○●○○○◀▶ Paper Size: 80 | 80/58 mm | Set according to the paper width |
|  ○○○○○○○○●○○○◀▶ Auto Shutdown: - | 1-5H | Set auto shutdown |
|  ○○○○○○○○○●○○○◀▶ Screen Saver: 10 | 10/30/60/99S | Set screensaver time |

4.3 Self-test

The self-test page will list the model of printer, communication interface configuration, etc.

Product information

Selftest
Firmware Ver:.....A43B1C3D0F0_V1.30 2019-02-14
Model:.....RPP320N
Interface:.....& USB
& wifi
& BlueTooth
Code Page:.....CP437[U.S.A.,Standard E]
Print Method:.....Direct Thermal
Print Duality:.....2
Print Density:.....2
Print Speed:.....4
Font:.....24x24GB 18030
Media Type:.....Receipt
Instruction Set:..... TSPL
Dpi:..... 203

Print size parameter

Size:.....0 mm, 0mm
Reference:.....0mm, 0mm
Shift:.....0mm
Offset:.....0mm
Milage(m):.....4.170000
TAIWANESE BIG5:.....TST24 . BF2
CHINESE GB2312:.....TSS24 . BF2
KOREAN KSC5601:.....K

POWER & DEGREE

[POWER & DEGREE]
VOLTAGE:7.482 DEGREE:27

Bluetooth Configure

[BlueTooth Configure]
EDR NAME:.....RPP320N-c02f-E
EDR PIN:.....0000
BLE PIN:.....000000
EDR ADDR:.....00-00-02-04-C0-2F
BLE ADDR:.....00-01-02-04-C0-2F
BT VERS:.....Apr 20 2017

WIFI Configure

[WIFI Configure]
Ethernet ID:.....1c-ed-b2-36-87-64
DHCP:.....Enabled
SSID:.....None
Ip:..... 152.61.100.152
Port:..... 9100
NetMask:..... 255.255.255.0



Bluetooth/WiFi information can be changed through the setting tool. For details, please refer to the "Instruction Manual for Setting Tool".



The self-test page is subject to the actual printer parameters!

V. Icon description



Printing status



This icon is displayed when the printer is printing or feeding paper.

Paper shortage state



When paper shortage occurs or the paper roll is not properly loaded

Cover opening state

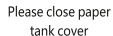

When the r paper bin cover is not closed or not properly closed

Battery indication



When charging, the icon will scroll to indicate the charging status

Bluetooth indicator



The printer has Bluetooth function

WiFi indicator



The printer has WiFi function (✓: indicates successful WiFi connection)

VI. Communication



6.1 USB Communication

RPP320N provides Micro USB port, which is used to connect the printer to a PC as shown in the figure to charge the printer, set parameters, and transmit data, etc.

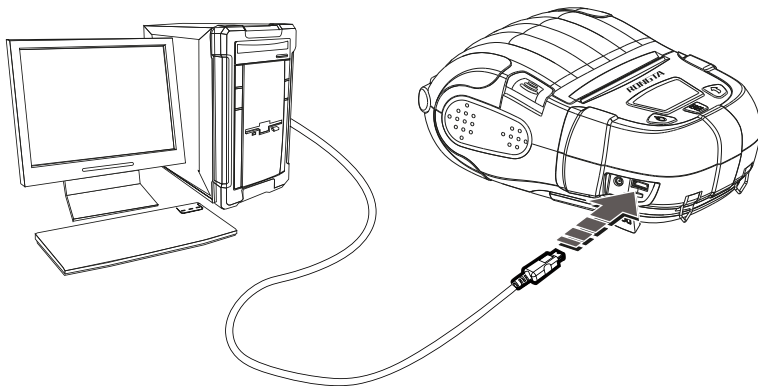

6.2 WiFi Communication

The RPP320N printer can provide WiFi communication, and support STA mode and TPIK/AES encryption. Its effective communication distance is no more than 20m.

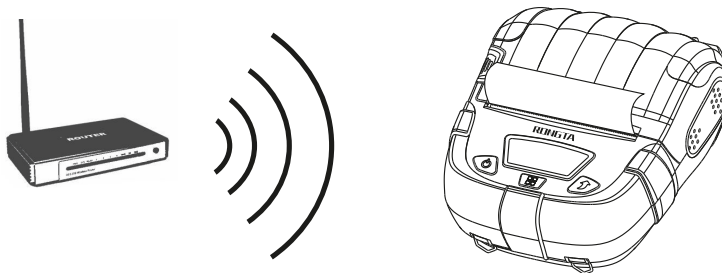

- WiFi information can be changed through the setting tool. For details, please refer to the "Instruction Manual for Setting Tool".

6.3 Bluetooth Communication

RPP320N provides dual-mode Bluetooth 4.0/5.2 (SPP+BLE) to communicate with iPhone、 iPad、 Android model, with the effective distance no more than 10 meters. It also supports AirSync protocol and Bluetooth function can be used on wechat platform.

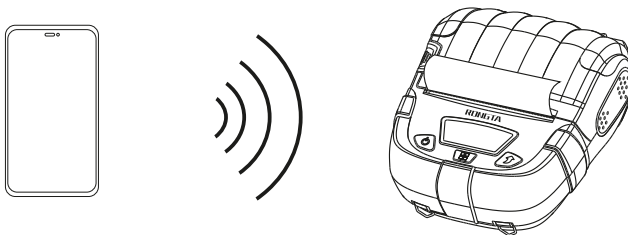

- ☑ The default pairing password of Bluetooth is 0000 or 1234 and the parameters can be set through the setting tool. For details, please refer to the "Instruction Manual for Setting Tool".

VII. Repair and Maintenance



7.1 Daily Maintenance of Printer

1. Cleaning of outside and paper bin: Wipe the surface of the printer and the inside of the paper bin gently with a wrung-out wet cloth. Make sure that the wet cloth is completely wrung out.
2. Cleaning of printer mechanism: The printer mechanism must be cleaned regularly, especially when the print quality declines. The cleaning method is as follows: Use absorbent cotton moistened with anhydrous alcohol to gently wipe the area marked with a gray box as shown in Fig. 1 until it is clean.

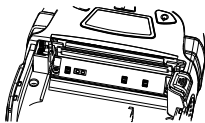

Fig 1

3. If water is found inside the printer, Turn it of immediately, remove the battery, and dry the printer by airing.
4. If the printer will not be used for a long time, remove the battery and store it separately.

7.2 Use and Storage of Printing Paper

1. Please keep newly purchased printing paper in intact package and prevent it from direct sunlight and high temperature.
2. Please keep printed documents in a dark place at room temperature (about 20°C), so as to effectively extend the storage life of the documents.
3. If the documents need to be kept for a long time, please use long-lasting thermal printing paper.

VIII. Troubleshooting



| Fault Phenomenon | Cause | Solution | Refer to page |
|---|---|--|---------------|
| Paper is fed but no data is printed. | Printing paper is loaded in the wrong direction. | Please load the printing paper in the other direction. | 8 |
| Blurry printing | The printer is not cleaned for a long time and the printer mechanism is contaminated by dirt. | Clean the printer mechanism. | 17 |
| | Poor color rendering of printing paper | Please set higher blackness or use paper with better color rendering | — |
| Printed documents are blurred in months or even weeks | Poor quality of printing paper | Please use long-lasting thermal printing paper | 17 |
| | Documents are kept at high ambient temperature | Please keep the documents at room temperature (about 20°C) | 17 |

IX. Appendix



9.1 Printer Parameters

| Printing Parameters | |
|-----------------------------------|---|
| Printing method | Thermal line printing |
| Printing paper width | 72mm |
| Print width | ≤50mm |
| Printing speed | ≤90mm/s |
| Resolution | 203dpi |
| Built-in font | GB 18030 |
| Service life of printer mechanism | 50km |
| Command set | ESC/POS/TSPL |
| Print length | >180m |
| Print content | One-dimensional code: UPC-A, UPC-E, EAN-13, EAN-8, CODE39, ITF, CODEBAR, CODE93, CODE128 QR code: QRCODE |

| Printing Parameters | |
|------------------------|---|
| Battery specification | 7.4V 2000mAh rechargeable lithium ion battery |
| Charging time | 6 hours |
| Wire communication | Standard USB2.0 |
| Wireless communication | Dual-mode Bluetooth Bluetooth 4.0/5.2 (SPP+BLE) |
| Dimensions | 140mmx117mmx60mm |
| weight | 0.45kg |
| Working environment | Temperature: 0°C~45°C, humidity: 20%~90% |
| Storage environment | Temperature: -10°C~60°C, humidity: 10%~90% |

9.2 Battery Recycling

This product uses a rechargeable lithium battery. To protect the environment, please do not dispose of used batteries at will. The supplier will provide you with battery recycling service.



Rongta Technology (Xiamen) Group Co., Ltd.

ADD: No.88, Tonghui South Road, Tongan, Xiamen, China.

WEB: www.rongtatech.com

TEL: 0086-592-5666129 FAX: 0086-592-5659169